

Article number: 03010016

Description: Fluro Rod End GASW 16  
Zinc Plated

## Measures

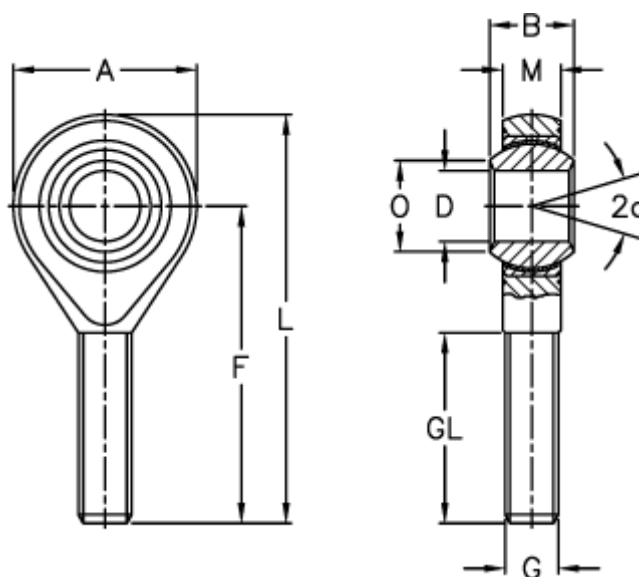

A	= 42	L	= 87
a (degrees)	= 15	M	= 15
B	= 21	O	= 19.3
D	= 16	Permissible rpm	= 230
Dynamic load C (kN)	= 52.5	Static load C0 (kN)	= 32
F	= 66	Weight (g)	= 189
g	= M16		
GL	= 40		